



SINGLE VERTICAL SPINDLE MOULDER, TYPE B.E.N.

PRINCIPAL DIMENSIONS AND CAPACITIES:

	English	Metric
Standard diameter top piece	1 3/4"	30 mm
Spindle speeds in r. p. m.	4500, 7200, 10,000	
Will deal with work up to	4"	100 mm
Rise and fall of spindle	4"	100 mm
Size of table	26" x 33"	660 x 838 mm
Height of table from floor	33"	838 mm
Floor space	33" x 26"	838 x 660 mm
Three circular table plates giving openings	3 1/2", 4 1/2", 7" and 9 1/2"	88 mm, 114 mm, 177 mm, 241 mm
Size of fence plates	4" deep 14" long	100 x 355 mm
Horsepower of motor	4	4
Net weight	530 lbs.	240 kg.
Shipping dimensions	3 8 1/2 cu. ft.	1.09 cu. m.

EQUIPMENT INCLUDED WITH MACHINE.

- 4 H. P. motor complete with suitable control gear.
- 1 3/4" dia. loose top piece, complete with nuts.
- Set of three spacing collars.
- Horseshoe type fences incorporating guard.
- Set of spanners.
- Lubricating pump and tin of ball bearing lubricant.

With all communications please quote machine number and test number from machine nameplate.

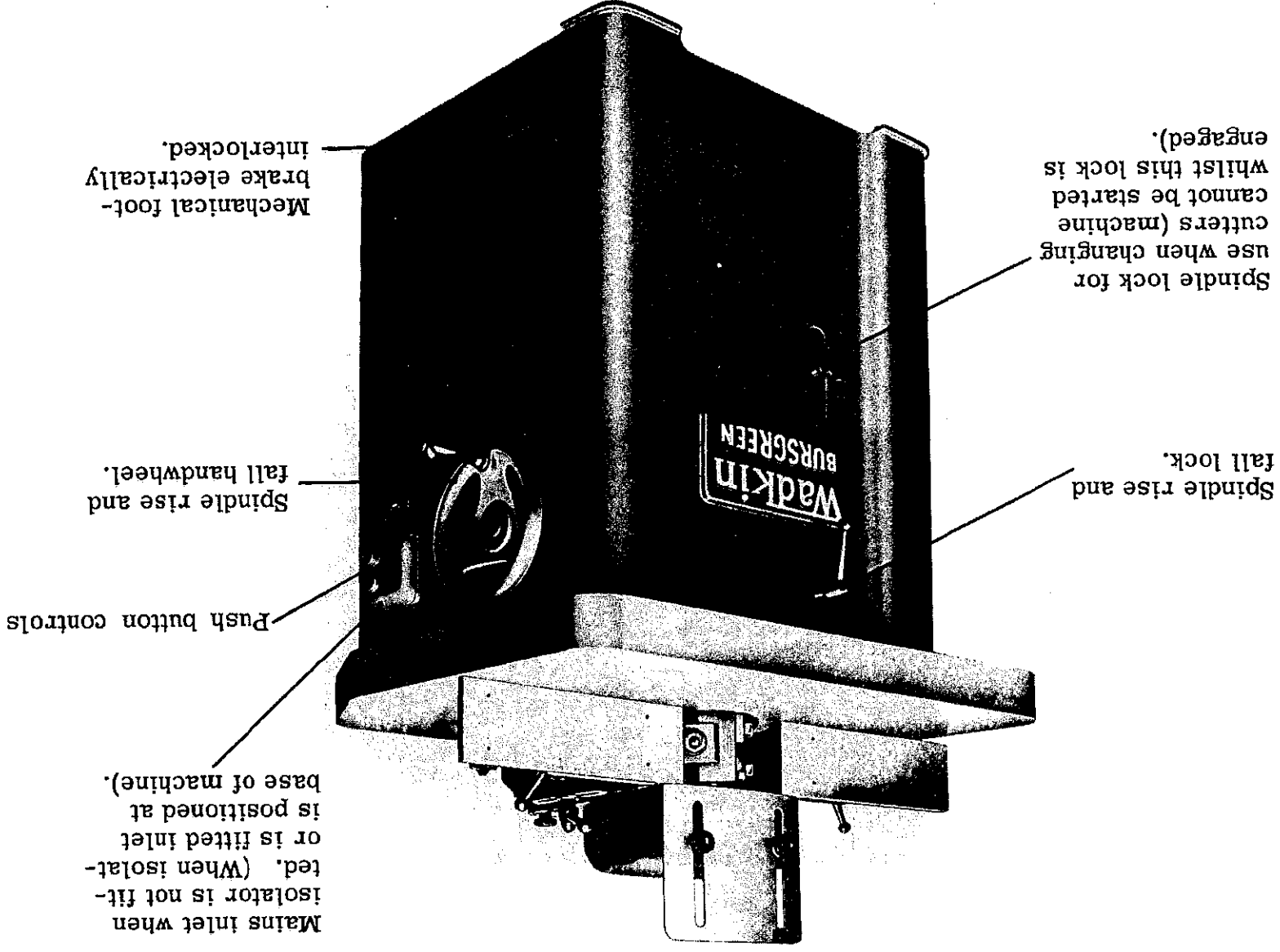
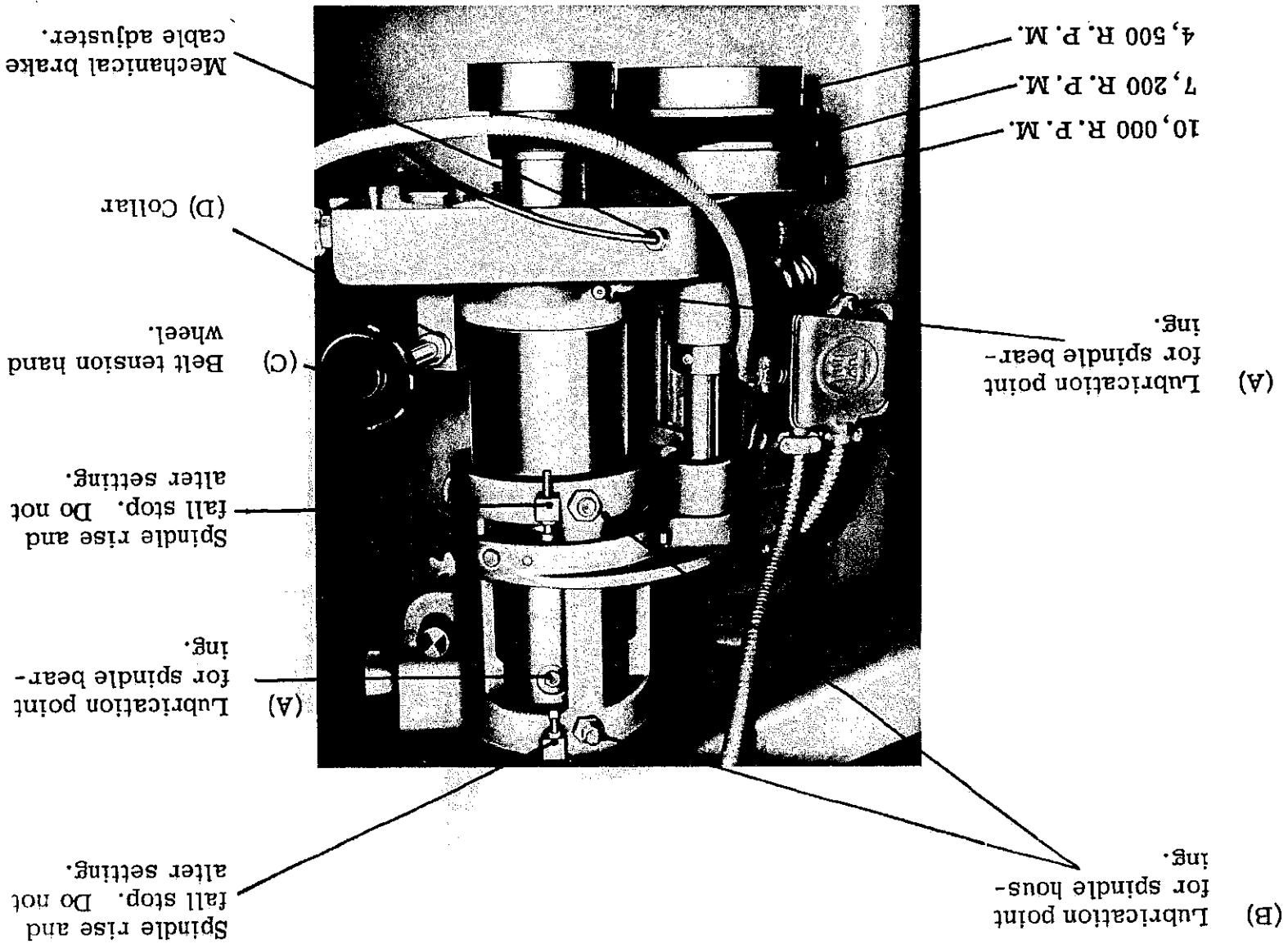

FIG. 2. FRONT VIEW OF VERTICAL SPINDLE MOULDER TYPE B. E. N.

FIG. 3. INTERNAL VIEW





LUBRICATION (SEE FIG. 3)

The lubrication of the bearings on this spindle moulder are covered by patent no. 697784.

The only lubricator necessary is an oil gun. A grease gun is not required. Keep the machine in good condition by maintaining a thin film of oil on the slide and on all bright parts not in constant use.

- A. 2 POINTS. Every day give one depression of the oil gun using Wadkin oil, Grade L. 1.
- B. 2 POINTS. Oil monthly using oil gun.

Every 12 months. Grease rise and fall screw and spiral gears.

Note : A motor without grease points is fitted on the machine. This has sealed bearings and required no lubrication.

WADKIN RANGE OF OIL AND GREASE WITH EQUIVALENTS

Equivalent Lubricants			
Wadkin Grade	Castrol	Mobil	Shell
High Speed Spindle Oil Grade L. 1.	Hyspin 70	Mobil DTE Oil Light	Tellus Oil 27
Ball Bearing Grease Grade L. 6.	Spherol AP3	Mobilux Grease No. 3	Alvania Grease No. 3

CHANGING THE SPEED AND RE-TENSIONING THE BELT. (SEE FIG. 3.)

The cutter spindle speeds available are 4,500, 7,200 & 10,000 r. p. m.

To change the speed the driving belt must be moved to another ratio of the pulleys. The largest diameter of the motor pulley giving the highest speed of 10,000 r. p. m. The middle step 7,200 r. p. m. and the smallest diameter of the motor pulley 4,500 r. p. m.

With the isolating switch "off" open the door at the side of the machine and adjust the motor by turning the handwheel "C" anticlockwise until the belt is released and can be easily fitted to the appropriate steps of the pulleys.

Re-tension by turning the handwheel clockwise. Spin the pulley by hand to ensure the belt is "tracking" correctly. Continue tensioning only until the collar "D" begins to move away from the face of the bracket.

Note: Should the tensioning procedure described above fail to give the correct tension the spring pressure should be adjusted as follows.

The belt tension shaft is fitted with a spring of $2\frac{7}{8}$ " free length, clamped by two locknuts on a left hand thread. Tighten or loosen the spring by means of the locknuts according to whether an increase or decrease in tension is required. The normal setting length of a new spring is 1.11/16" giving a pressure of $29\frac{1}{2}$ lbs. which varies by $3\frac{1}{4}$ lbs. for every 1/16" of adjustment.

IMPORTANT :- Do not attempt to run the machine with the belt insufficiently tensioned. Close the door before starting the machine.

THE CUTTER SPINDLE UNIT

DISMANTLING (To fit new bearings) SEE FIG. 4.

1. Isolate machine.
2. Unscrew four countersunk head screws and re-move end cap "A".
3. Remove driving belt.
4. Remove 1" dia. Whit. left hand threaded locknuts "B" and washer "C".
5. Withdraw spindle lock.
6. Remove pulley "D", brake drum "E" and withdraw driving key from spindle.
7. Knock out spindle in direction of arrow "F" using a piece of wood or soft metal (brass, copper, lead).
8. Spindle top bearing can now be changed by slackening off two countersunk head screws and re-moving locknut "G" (this locknut has left hand thread and is 2.13/32" across flats) permitting felt ring housing "H" spacing sleeve "I" and bearing to be removed.
9. Remove bottom bearing housing "J" from spindle housing.
10. Unscrew four countersunk head screws and re-move end cap "K" bearing can now be knocked out of housing.
11. Fit new bearings and reassemble in reverse order to the operations above and on page 5 and 6. Clean all parts thoroughly before re-fitting especially inside the ball bearing housings. Renew the felt oil rings if necessary but always soak in Grade L. 1 spindle oil before fitting and ensure that the four wicks are in place to feed each bearing.

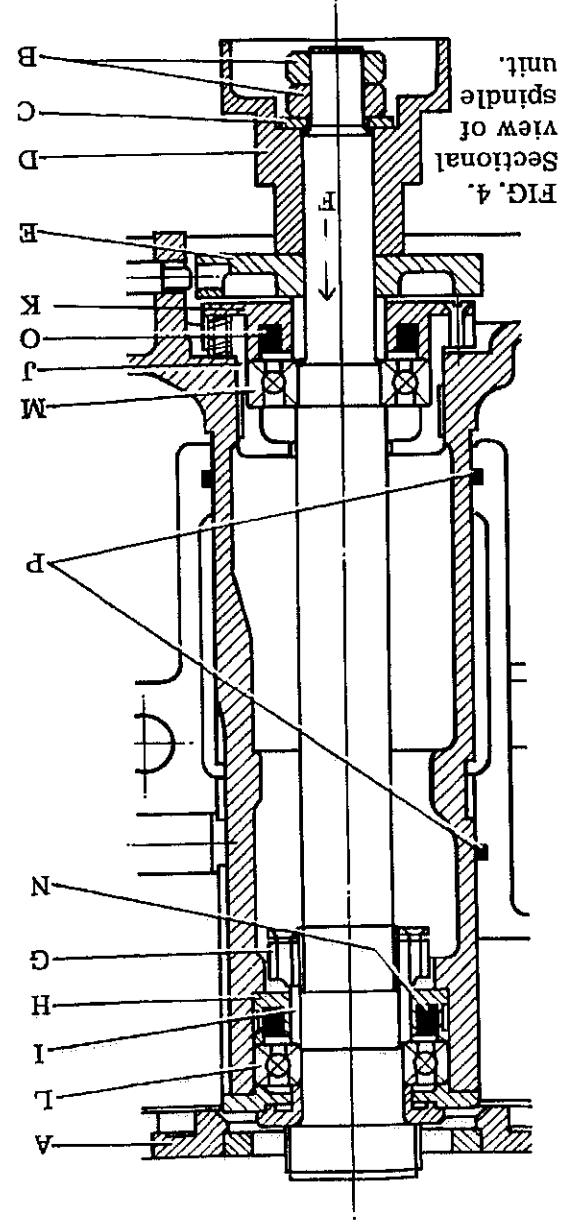

FIG. 4.
Sectional
view of
spindle
unit.



SERVICE AND SPARES

Given regular attention and maintenance as recommended in this manual, the Wadkin Spindle Moulder should give continuous trouble-free service. Apart from items such as Belts or Bearings, replacement parts are unlikely to be required. For this reason no Spare Parts List is issued. Should, however, any part of the machine sustain accidental damage, necessitating its replacement, the drawings and illustrations in this book will enable the part to be accurately specified and thus enable our Service Department to send the replacement promptly.

REPLACEMENT BEARINGS.

The Spindle Ball Bearings as detailed on page 7 are specially made for us by the Hoffmann Manufacturing Co. Ltd. to extra precision limits and we strongly recommend users to order from our Service Department should replacement bearings become necessary.

Spindle Bearing (L)	Hoffmann N 5284	45 x 85 x 19 m/m
Spindle Bearing (M)	Hoffmann N 3145	35 x 80 x 21 m/m

REPLACEMENT BELTS.

The 'Hevaltex' belt transmitting power to the spindle is specially made to length and endless to the sizes listed on below. All sizes are kept in stock by the Wadkin Service Department. To ensure efficient running of the machine it is strongly recommended that only Belts supplied by Wadkin are used.

Replacement Belt for 50 cycle machines. 890 m/m long x 20 m/m wide.
 Replacement Belt for 60 cycle machines. 850 m/m long x 20 m/m wide.

Replacement Felt Rings

- (N) 8 $\frac{1}{2}$ " length $\frac{3}{8}$ " x $\frac{1}{2}$ " section grade A. P. W. felt.
- (O) 7 $\frac{1}{2}$ " length $\frac{3}{8}$ " x $\frac{3}{4}$ " section grade A. P. W. felt.
- (P) 28" length 3/16" sq. section grade A. P. W. felt.

DIAGRAM OF CONNECTIONS D. 1254/1.

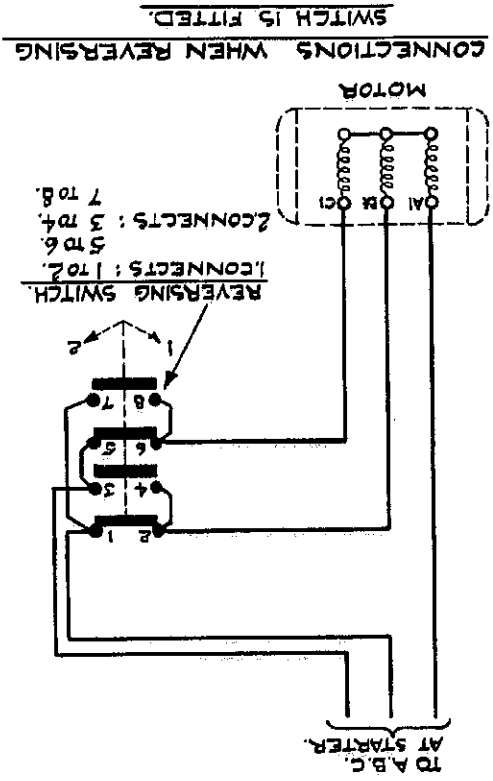
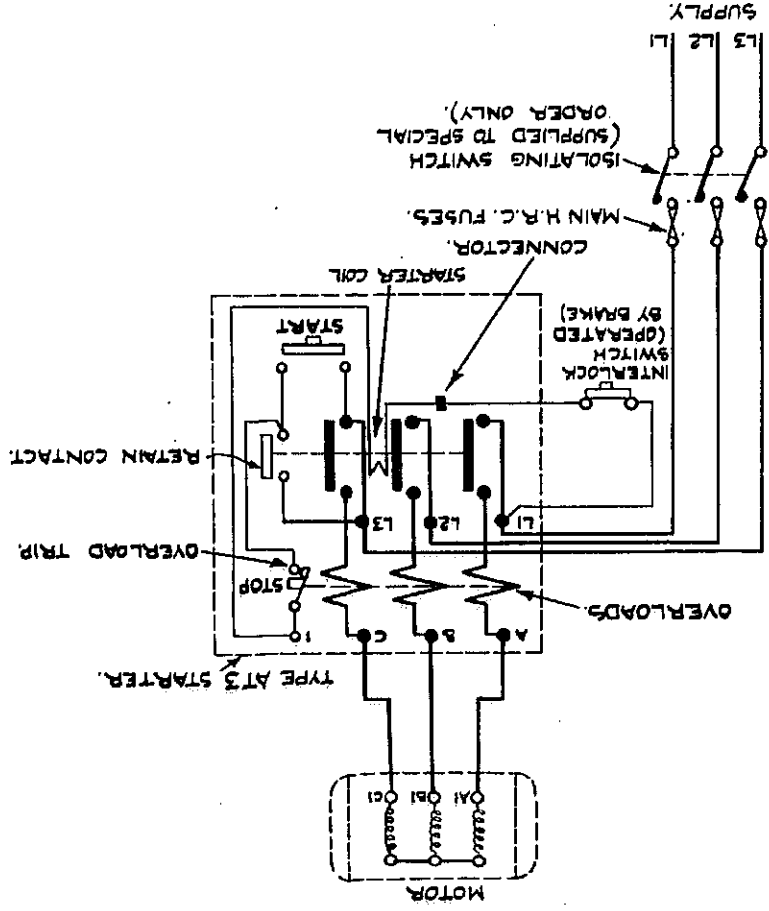



ELECTRICAL INSTALLATION INSTRUCTIONS

The cabling between the motor and the control gear has been carried out by Wadkin Ltd, and it is only necessary to bring the line leads to the machine for it to be put into service. This should be done as follows:-

- (1) Fit triple pole isolating switch near the machine, unless this has been supplied to special order by Wadkin Ltd, when it will be fitted and connected up at the machine.
- (2) Connect the line lead to the appropriate terminals, see diagram. The cables should be taken to the machine in conduit and secured to the control gear by means of locknuts.
- (3) Connect solidly to earth.
- (4) Close isolating switch and press start button. If machine does not rotate in the right direction, interchange any two of connections L1, L2, L3 on the contactor.

FAILURE TO START.

- (1) Electric supply is not available at the machine.
- (2) Fuses have blown or have not been fitted.
- (3) Isolating switch has not been closed.
- (4) Lock-off or stop button has not been released.

STOPPAGE DURING OPERATION AND FAILURE TO RESTART.

- (1) Fuses have blown.
- (2) Overloads have tripped. They will reset automatically after a short time, and the machine can be restarted in the usual manner.

ADJUSTMENT

For a finer overload setting, set the load indicator to a lower value, and vice-versa for a less fine setting.

GENERAL

Check the earth connection from time to time. Users are recommended to display in an appropriate position in the maintenance department Wadkin Electrical Maintenance Instruction Card, No. 356, which is issued gratis on application.

CUTTERS AND CUTTER STEELS FOR SPINDLE MOULDERS

Special grades of steel are used for making cutters for different duties and applications on the spindle moulder. The following is a rough guide and when in doubt, our Cutter Department should be consulted. HIGH SPEED STEEL ON IRON is used for long life and for cutting hard woods. High speed steel is very brittle and the steel on iron is used for all types of unsupported irons. It is used on the square block, slotted collars, thin knife moulding blocks and also for cutters for use on collar type french spindles running at 10,000 r.p.m. A large range of irons for the square block and collars are stocked in this steel.

SOLID HIGH SPEED STEEL is very brittle and is only used where the cutters are supported very close up to the cutting edge, e.g. a thin knife on the circular block, or where a strong section can be used such as a milled to pattern slotted collar cutter.

ALLOY STEEL ON IRON is less expensive than high speed steel on iron, and is more ductile. Our standard range of slotted collar and square block cutters are stocked in this steel. Alloy steel is not so hard and will not stand up to heavy cutting or hard woods as well as high speed steel.

SOLID ALLOY STEEL is normally supplied in bar form in the soft condition for cutting up by the customer. It is easily hardened and tempered and is normally used for french spindle work up to 6,000 r.p.m. where cutters are held by locking screw in spindle, locking direct on to the side of the cutter.

All the above types are supplied in bar form, micrometer ground to precision limits. The alloy and alloy on iron $3/16'' \times \frac{3}{8}''$ up to $\frac{1}{2}'' \times 3''$ in the soft condition and the high speed steel $5/32'' \times 1\frac{1}{2}''$ and $5/32'' \times 2''$, and high speed steel on iron $\frac{1}{4}'' \times 1\frac{1}{2}''$ and $\frac{1}{2}'' \times 1\frac{1}{2}''$ in the heat treated condition. These latter bars cannot be cut with a tool and the blanks should be ordered to grinding lengths so that we can cut them off with a grinding wheel, if the user has not this type of equipment.

For details of all types of cutters, sizes of bar steel and heat treatment see our Small Tools Leaflet, Section C.

All the above cutters can be ground on the usual standard grinding equipment.

TUNGSTEN CARBIDE TIPS. These are specially made for use on hardwoods, woods with high silica content also plywoods and hardboard where High Speed Steel will not stand up to the abrasive action. It is much more expensive but gives very much longer life. We carry a limited range of these cutters for use in slotted collars and square blocks. Special shapes can be supplied to order.

When using Tungsten Carbide Tips, it is necessary to have special grinding equipment; diamond impregnated wheels are required for grinding and diamond hand laps for honing. These are expensive and this should be borne in mind when choosing cutters.



CUTTER EQUIPMENT FOR USE ON SPINDLE MOULDERS

We have given on the following pages maximum sizes and cutting diameters for the equipment shown. Where it is considered by the customer to be necessary to exceed the figures given, details of the proposed method of working and the moulding to be worked should be sent to Wadkin Ltd., who will be pleased to advise and if necessary recommend special equipment.

Most equipment is offered Right and Left Hand for use on Double Spindles and Single Spindles when a reversing switch is supplied. Equipment listed as Right Hand (R. H.) is suitable for single spindle machines running in the normal direction of rotation as shown in the diagram.

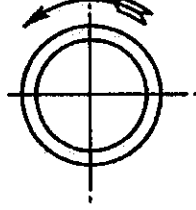

Normal direction of single spindle looking down on top of spindle.

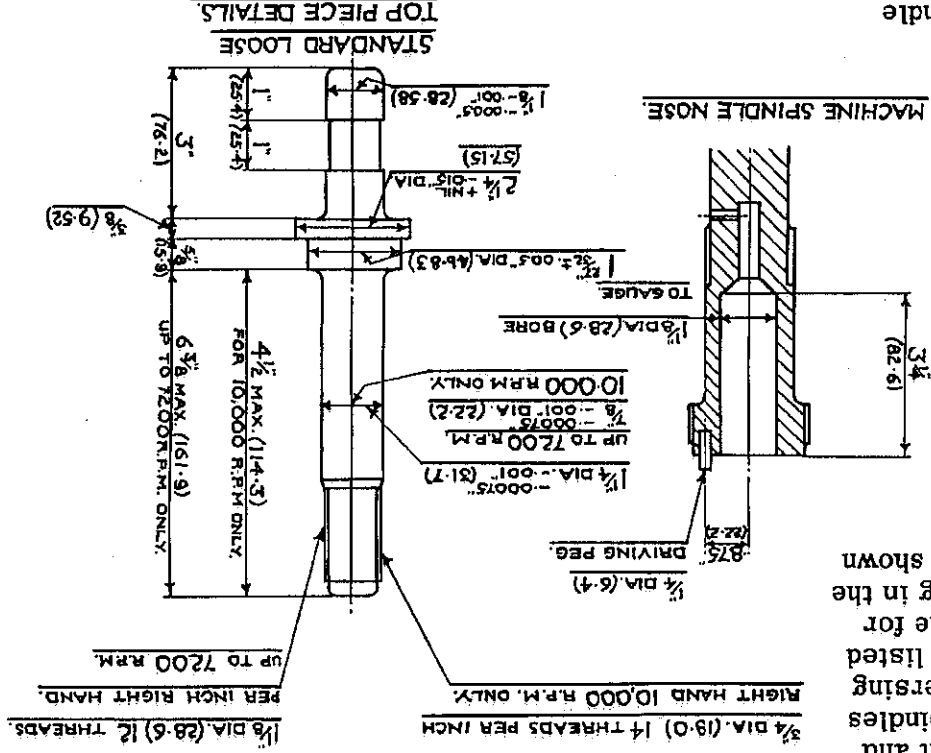

NOTE:- It is most important that the recommended speeds of the various types of equipment listed on the following pages are not exceeded. The speeds provided on the Wadkin Spindle Moulder are stamped on the nameplate.

EQUIPMENT FOR USE ON SPINDLE MOULDERS
RUNNING AT SPEEDS OF 4,500 AND 7,200 R. P. M.

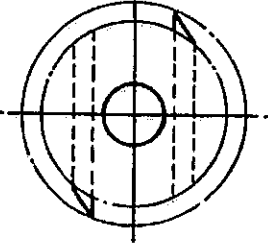
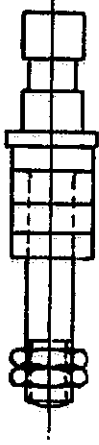

3/8" minimum 5" maximum
diameter cutting circle

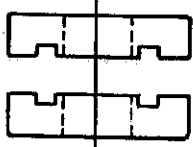

LOOSE TOP PIECES used for
equipment on pages 13-17 inclusive.

1" dia.
ENT 30
1 1/2" dia.
ENT 34
30 mm. dia.
ENT 45

MAKING UP COLLARS

1" Bore 1 1/2" Bore 30 mm. Bore
L.P189 3/8" QZ5 1" ENT 50 1"
L.P190 1/2" QZ6 1" ENT 51 1 1/2"
QZ1 1" QZ7 1 1/4" ENT 52 1 1/2"
QZ2 1 1/4" QZ8 1 3/8"
QZ3 1 1/2" QZ9 2"

PLAIN SLOTTED COLLARS

Can be used at 4,500 or 7,200 r. p. m.
1" bore 2 1/2" dia. SBF 584 & 585
1 1/2" bore 2.15/16" dia. SBF 580 & 581

If required one collar can be supplied
a larger diameter to give extra
support to cutters.

If vee slotted collars are preferred,
these and vee cutters can be offered.

Slotted collar cutters have many
advantages, they have good cutting
angle, a fairly small cutting circle of
3 5/8" dia., easy to shape, maintain and
re-grind and also inexpensive. They
are not safe to use above 5" maxi-
mum diameter due to the lack of
strength and support also the grip
on the cutters is less effective as the
cutter is set farther away from the spindle. There can
be no side adjustment of collar cutters which is a great
disadvantage. We have a limited range of tungsten
carbide cutters available and can supply most shapes to
order.

1 1/4" DIA. BORE VEE SLOTTED
COLLARS 2.15/16" DIA. E. P. 231.
USE AT 4,500 R. P. M.

The vee slots make it possible to use
very much thicker cutters, for
example the:

**MILLED TO PATTERN COLLAR
CUTTERS FOR REVERSIBLE JOINT**

(Dimension A 1/2" - 1" E. P. 234
A 3/8" - 1 1/4" E. P. 235).
These cutters are more expensive
but have a very long life and main-
tain their original form throughout
their life. They can be supplied
to certain other shapes if customer
will give us details of his moulds.

**1 1/4" BORE 3 5/8" DIA. BALL BEARING
SLOTTED COLLARS**

USE AT 4,500 R. P. M.

These can be supplied as follows:

- Ball bearing bottom and plain top.
- Plain bottom and ball bearing top.
- Ball bearing top and bottom.
- Ball bearing collar Q. Y. 3.
- Plain collar Q. Y. 4.

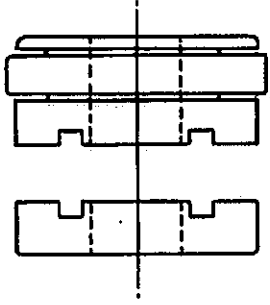

NOTE:

Where existing 1" dia. bore equipment is already in use,
we can offer 1" dia. top piece and all the above collars
1" bore with the same outside diameters.

FOR FULL DETAILS OF ABOVE AND FULL RANGE OF CUTTERS STOCKED SEE SECTIONS C AND D OF OUR TOOLS

AND SUNDRIES CATALOGUE.



DETAILS OF SQUARE AND CIRCULAR CUTTERBLOCKS

3 1/2" SQUARE 1 1/2" BORE DOVETAIL CUTTERBLOCKS.

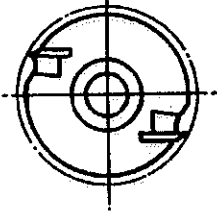

4 1/2" DIA. CUTTING CIRCLE 1 1/2" DIA. BORE SAFETY CIRCULAR CUTTERBLOCK

LENGTH	PART NO.	USE AT
3"	Q.W.1	4,500 R.P.M.
4"	Q.W.2	4,500 R.P.M.

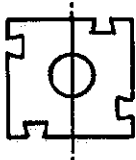

These cutterblocks are used for longer runs, cutters working in pairs, several pairs may be mounted on a single block to build up mould.

The cutters on these cutterblocks have a very good cutting angle. They are 5/8" thick and are securely held by dovetail bolts. It is therefore possible to have a large overhang allowing deep moulds to be worked with safety up to the maximum cutting circle of 7 1/2" dia.

Cutting circle
Minimum 5 1/2" dia.
Maximum 7 1/2" dia.
meter.

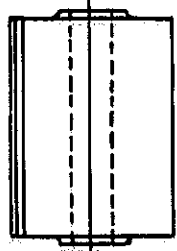

These cutterblocks have wedge type clamping for safety, also adjusting screws for easy, accurate setting of cutters. They are smooth running and are used for facing. They have a good cutting action and a small cutting dia. of 4 1/2". These blocks can be supplied with spur cutters on top or bottom edges, or both.

BALL BEARING GUIDES FOR USE WITH THE ABOVE.

For use at 4,500 r.p.m. only. These can be supplied top, bottom or both if required. With Q.H.2 cutterblock only.



The Q.H. type circular cutterblocks can, if required, be supplied with spur cutters for shoulder work across the grain.

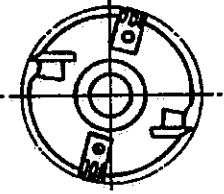

For standard cutters see Section C of our Tools and Sundries Catalogue. If closed slot cutters are preferred, see FCT 999 range on pages 9 and 10 of the above section. A limited range of Tungsten Carbide Tipped cutters are available. Shaped cutters can be provided to special order.

All the above can be supplied for use with existing 1" dia. top pieces.

FOR FULL DETAILS OF THE ABOVE SEE SECTION D OF OUR TOOLS AND SUNDRIES CATALOGUE.

CUTTERBLOCK FLUSH MOUNTED ON SPECIAL LOOSE TOP PIECE

QR42 5.3/8" DIA. x 15/16" THICK.
CAN BE USED AT 4,500 or 7,200 R.P.M.

This cutterblock is used with a special loose top piece ENT 16.
It is used for throating works on sills etc.
Special shaped cutters can be supplied if required.

TWO KNIFE WEDGE TYPE CIRCULAR CUTTERBLOCKS
(PLAIN BORE QR TYPE)

CAN BE USED AT 4,500 or 7,200 R.P.M.

4" diam. x 15/16" thick x 1" bore. Part No. QR60.
This block uses 5/32" thick cutters only.

- 4 7/8" diam. x 15/16" thick x 1 1/4" bore. Part No. QR11/B.
- 4 7/8" diam. x 15/16" thick x 1 1/4" bore. Part No. QR1/B.
- 5 3/8" diam. x 15/16" thick x 1 1/4" bore. Part No. QR4.
- 4 7/8" diam. x 1 1/2" thick x 1 1/4" bore. Part No. QR2.
- 4 7/8" diam. x 1 1/2" thick x 1 1/4" bore. Part No. QR10.
- 4 7/8" diam. x 2" thick x 1 1/4" bore, with top and bottom bevels. Part No. QR57.
- 4 7/8" diam. x 2" thick square face x 1 1/4" bore. Part No. QR3.
- 4 7/8" diam. x 2" thick x 1 1/4" bore 4 knife. Part No. QR66.
- 4 7/8" diam. x 1 1/2" thick x 1 1/4" bore with top bevel only.

These cutterblocks are designed to take 5/32" up to 5/8" thick cutters: this permits tungsten carbide tipped cutters to be used when necessary.

The cutters can be used for mouldings requiring not more than 5/8" cutter projection when using 5/8" thick cutters.

Our standard VZ range of cutters on page 9 of Section D, Tools Catalogue, can be used in these cutterblocks, also existing Whitehill head cutters.

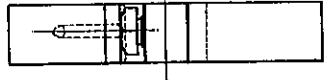
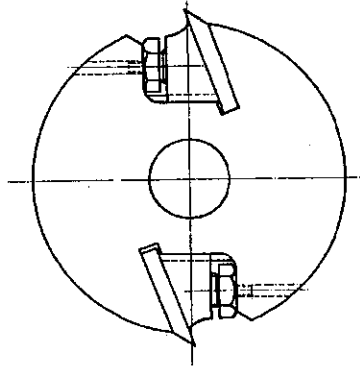
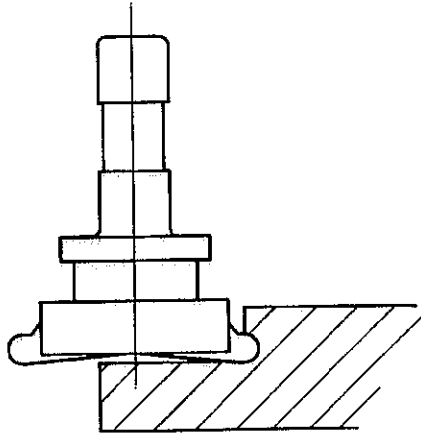

EQUIPMENT FOR USE ON SPINDLE MOULDERS

CARBON STEEL SIDE TOOTH CLEARANCE TYPE SAW.
When enquiring please give width and maximum depth of cut required. These are cheaper than inserted tooth saws and are used for general grooving work. They are not suitable for hardwoods.

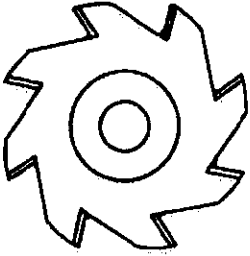

LIGHT TYPE WOBBLE OR GROOVING SAW UNIT
These saws are used where varied widths of grooving are called for, and where quantities are small. They are not recommended for quantity production or where precision accuracy or the highest standard of finish is required.



8" diam. $\frac{3}{8}$ " to $1\frac{3}{8}$ " grooves. Maximum 4,500 r.p.m.

HEAVY TYPE WOBBLE SAW UNIT ON SCREWED SLEEVE
Once set, the saw and collars remain tightly locked on sleeve. This type may be set and kept at its setting when not on machine. It is a self-contained unit.

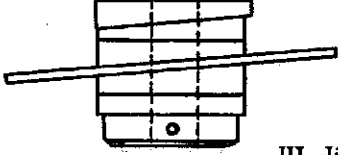

8" diam. $\frac{3}{8}$ " to $1\frac{7}{16}$ " grooves. Maximum 4,500 r.p.m.

SOLID MOULDING CUTTERS.
Made to any required pattern. When enquiring please send either drawing or sample mould. These cutters are used where long runs are required and shape must be maintained. Careful and accurate grinding is required to ensure constant results.



Cutters are supplied in High Speed Steel or Carbon Chrome Steel for long life and to stand up to hardwoods.

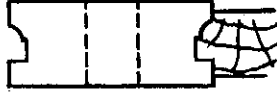

HIGH SPEED STEEL INSERTED TOOTH GROOVING SAWS.

Maximum speed 4,500 r.p.m. When enquiring please give width and maximum depth of cut required. These saws are used for accurate high grade work. They are fairly expensive and require good handling. They are available 6" diameter in varying widths on cut.

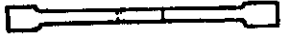
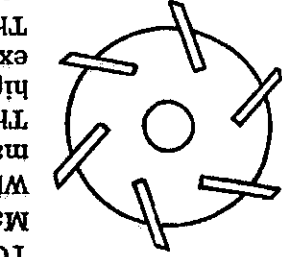

FOR FULL DETAILS OF THE ABOVE SEE SECTIONS A, D, AND E, OF OUR TOOLS AND SUNDRIES CATALOGUE.

ATTACHMENTS FOR SPINDLE MOULDERS

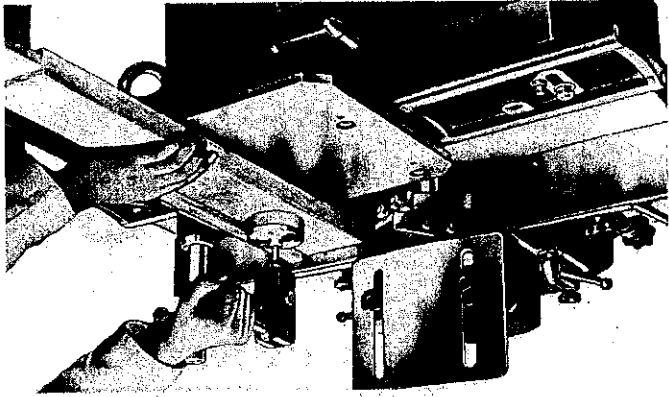

TENONING ATTACHMENT

When working tenons, use 4,500 r.p.m. spindle speed only.
For tenons up to $2\frac{1}{2}$ " x 1", E.N.T. 38 & 39 heads 7" dia. min. 8" dia. max.

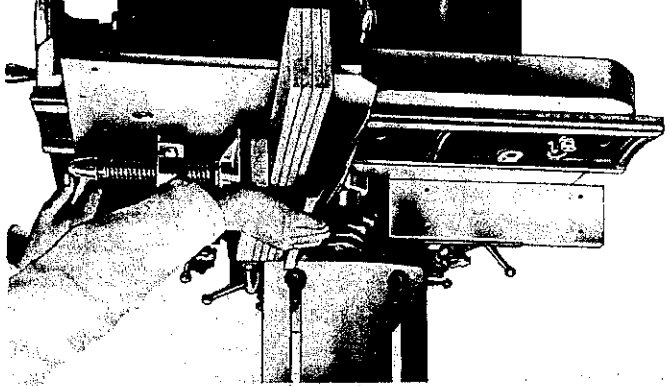

CORNER LOCKING ATTACHMENT E. F.

Up to 3" maximum depth with top piece E. N. T. 28. Speed 4,500 r.p.m.

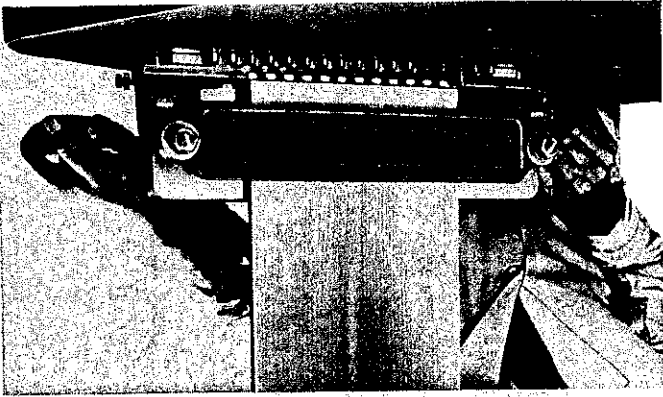

DOVETAILING ATTACHMENT E. F.

This attachment can also be supplied for use at 7,200 r.p.m. using comb plate and standard cutters.

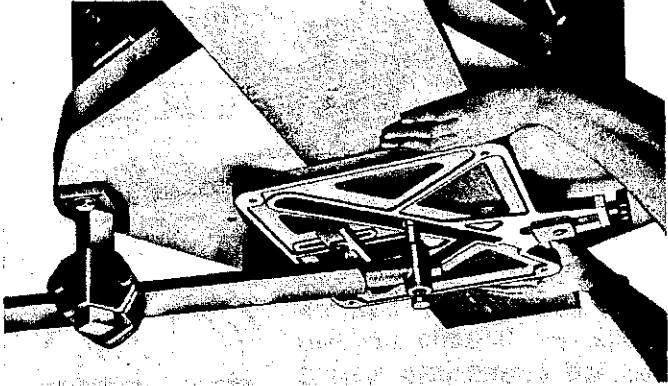

STAIR HOUSING ATTACHMENT. (For speeds up to 10,000 r.p.m.)

FOR FULL DETAILS OF EQUIPMENT FOR EACH OF THESE ATTACHMENTS SEE SECTION D OF OUR TOOLS AND SUPPLIES CATALOGUE.

CUTTER EQUIPMENT FOR USE ON SPINDLE MOULDERS
RUNNING AT SPEEDS UP TO 10,000 R.P.M.

FRENCH SPINDLES COLLAR
TYPE.

This type is specially made for safety at high speeds and gives more support to cutters.

2" dia. collar French spindle complete with two making up collars.

R. H. Spindle E. N. T. 10.

Maximum width on cut 2"
Maximum cutting dia. $3\frac{1}{2}$ "

2 $\frac{1}{2}$ " dia. collar French spindle complete with three making up collars.

R. H. Spindle E. N. T. 12.

Maximum width on cut $2\frac{1}{2}$ "
Maximum cutting dia. $4\frac{3}{8}$ "

Cutters for these spindles are supplied in High Speed Steel on Iron to stand up to the high spin-

die speed and to give longer life.

These French Spindles can be fitted with one large diameter collar to give extra support to cutters on deep moulds. Pros-

pective user should consult Wadkin Ltd. on these applica-

tions.

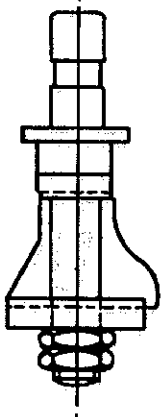
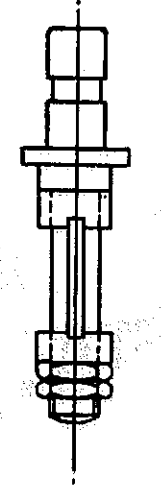

$\frac{7}{8}$ " DIA. STUB TOP PIECE.

R. H. Spindle E. N. T. 2.

MAKING UP COLLARS.

$\frac{1}{4}$ ", $\frac{3}{8}$ ", and $\frac{1}{2}$ " thick.
E. Z. 295, 296 and 297.

SLOTTED COLLARS. 2. 3/16"

DIA. E. Z. 310.

Fitted with safety peg to prevent coming out when running at high speed.

These have a maximum width on cut of $2\frac{1}{4}$ ".

$\frac{3}{4}$ " wide slots with safety pegs in bottom collar only.

COLLAR CUTTERS.

With safety slots for use Speed Steel on Iron. $\frac{3}{8}$ " to $2\frac{1}{2}$ " on cut x $2\frac{3}{8}$ " long.

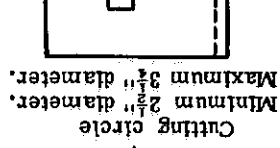
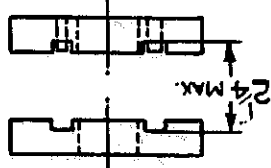
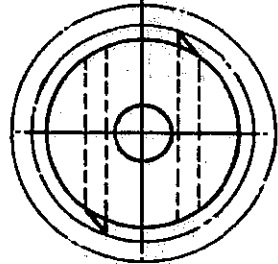
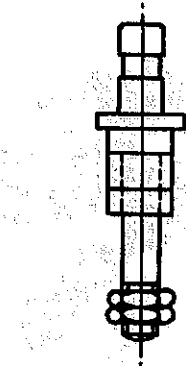

NOTE. THE STANDARD RANGE OF EQUIPMENT FOR RUNNING AT SPEEDS UP TO 7,200 R.P.M. MUST NOT BE USED ON MACHINES WHEN RUNNING AT HIGHER SPEEDS

CUTTER EQUIPMENT FOR USE ON SPINDLE MOULDERS
RUNNING AT SPEEDS UP TO 10,000 R.P.M.

OVERHEAD GUIDE ROLLER FIXTURE.
This enables maximum capacity to be used on all equipment by guiding above work.

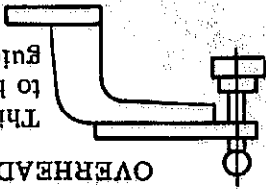

$3\frac{1}{2}$ " dia. roller E. Q. Z. For use with E. Z. 306 circular cutterblocks.
 $3\frac{5}{8}$ " dia. roller E. Q. Z. 12. For use with slotted collars 2.15/16" dia.
 $4\frac{1}{4}$ " dia. roller E. Q. Z. 14. For use with Q. H. type circular cutterblocks.

ROUTER COLLET ADAPTER TO TAKE STANDARD "H" TYPE COLLETS.

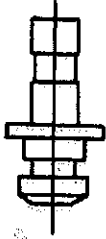

Supplied complete with $\frac{5}{8}$ ", $\frac{7}{8}$ " and 9/16" collets.
R. H. Adapter E. N. T. 14.
For use with Router cutter equipment.

CIRCULAR CUTTERBLOCK
L. S. 1943.

For both L. H. and R. H. direction of rotation. For light small diameter work.
Cutters L. S. 1943D.

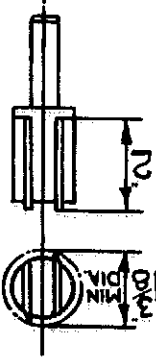

$3\frac{1}{2}$ " DIA. CUTTING CIRCLE
 $\frac{5}{8}$ " BORE SAFETY CIRCULAR CUTTERBLOCK.

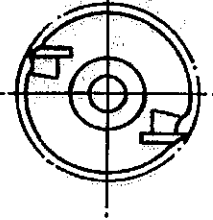

Maximum depth $2\frac{1}{2}$ " on stub top piece.
Fitted with serrated back cutters.
Serrated back cutters.
2.5/16" on cut x $1\frac{1}{2}$ " E. Z. 303.
2.5/16" on cut x 1.13/16" for use when making shape moulding cutters E. Z. 304.

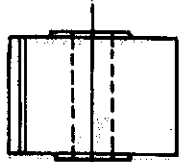

$4\frac{1}{2}$ " DIA. DEAD GUIDE RING TO FIT IN TABLE, for use with Q. H. 2 and 3 cutterblocks.

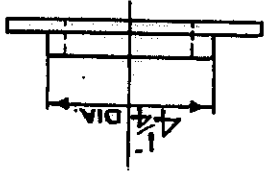

$4\frac{1}{2}$ " DIA. BALL BEARING GUIDE TO FIT IN TABLE complete with spacing collar for top piece. Due to thickness of guide this may only be used with cutterblock Q. H. 2.

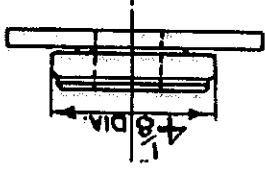

WE RECOMMEND THAT ANY GUIDES REQUIRED AS ABOVE SHOULD BE ORDERED WITH THE MACHINE, SO THAT THEY MAY BE FITTED BEFORE LEAVING OUR WORKS.

USE OF GUARDS AND FENCES

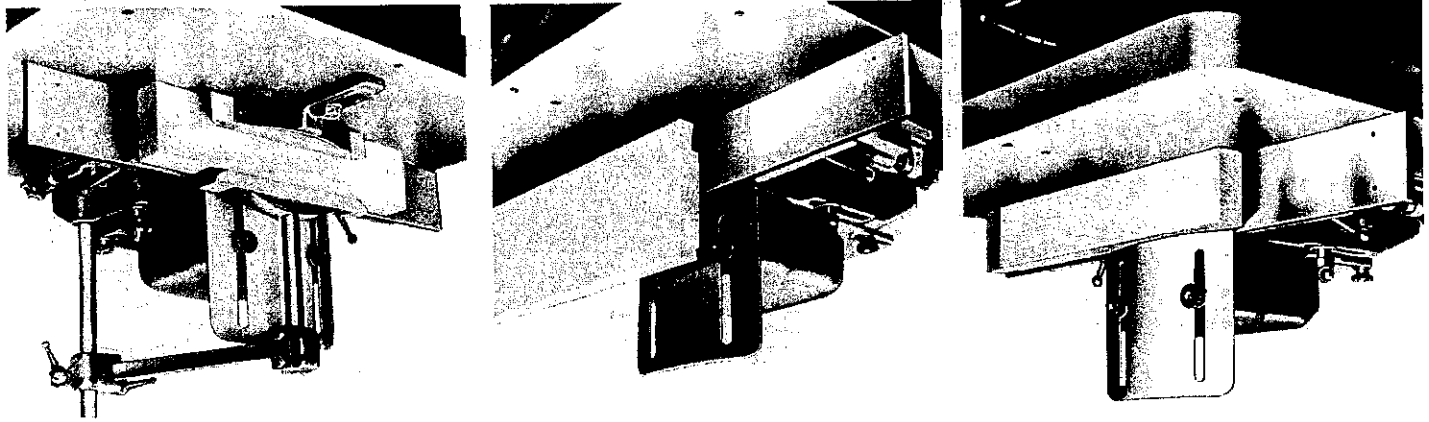

The standard fence has independently adjustable front plates each 4" deep. They are provided with lateral sliding movement and drilled for fixing wooden fences. (Right) The guard can easily be adjusted to allow deep stock to be machined.

For deep curved work a double ring fence should be used with a universal guard to give maximum rigidity to the work and safety to the operator.

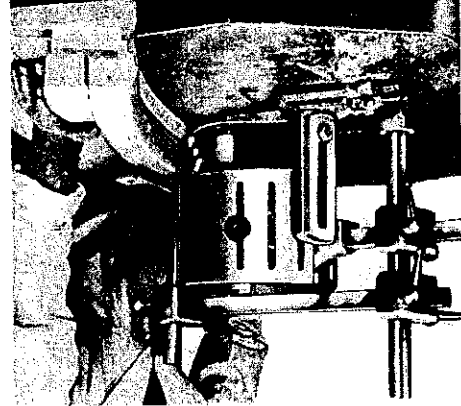
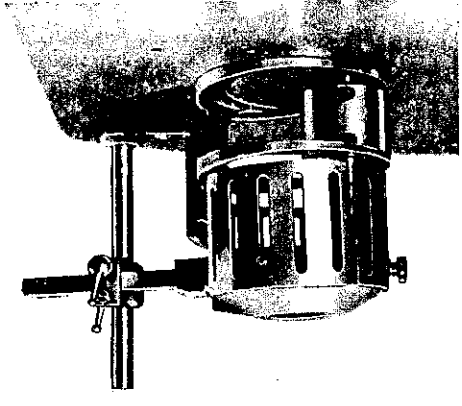

A typical set-up for curved work using a single ring fence, a universal guard and a Shaw type



Ring fences can be used as either single or double units for all types of curved work. They are supplied with internal diameters of 6 1/2" or 4 1/2".

SHAPING CUTTERS

When shaping cutters for any mould on any type of cutterhead or slotted collars it is important that the correct allowance is made to the depth of form cutter.

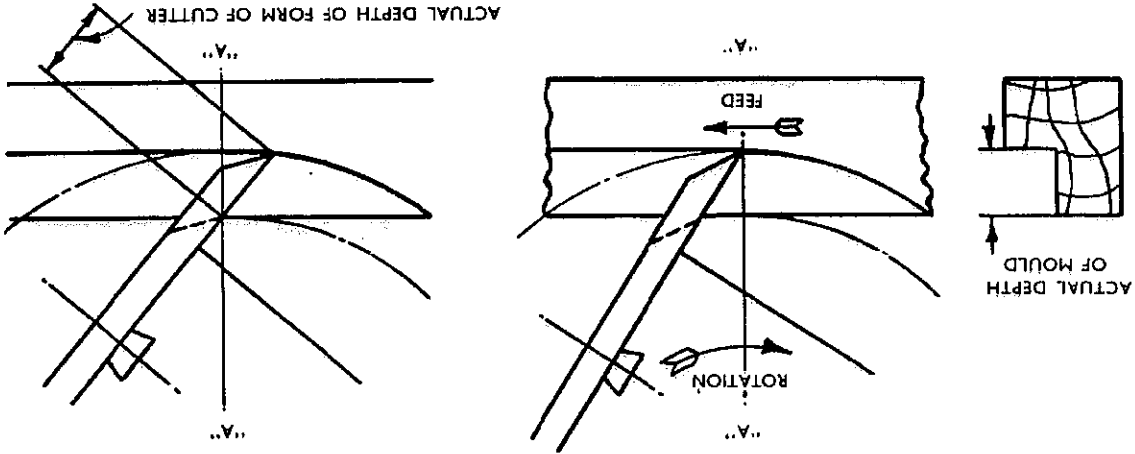

The above illustration shows the projection of the cutter to produce a simple rebate. Using the $3\frac{1}{2}$ " square range of standard cutterblocks, to produce a 1" deep rebate the cutter must have a depth of form of 1.3/16" this being due to the angle at which the cutter strikes the work on the line A-A. When a shaped mould is required to be cut it is necessary to plot out the form of the cutter, this is shown in the next illustration.

It is important that when selecting blanks from which to make the cutter that they have the minimum necessary overhang to produce the mould. This is essential for safety purposes. Also, a blank as near the shape and width as possible should be selected so that there will be less waste and less chance of overheating cutters when grinding. The minimum cutting track is fixed to give the necessary clearance for the bolt head when working with chipper only. The cutter angle which is normally 35° is shown at "X" and the cutting angle at "Y", this angle varies with the size of cutterblock and the depth of the mould.

57" DIA. MINIMUM CUTTING CIRCLE

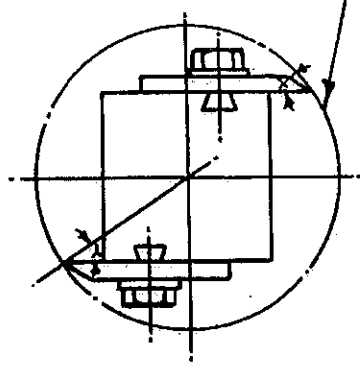



SHAPING CUTTERS (Contd.)

To obtain the correct cutter form for a shaped mould, without using the moulder's rule, it is necessary to plot this out as shown.

First the square block and cutter at minimum track are drawn out full size at "Y", the radius of the minimum track is drawn round to the centre line and projected down, this is then used as the base line for the mould at "Z". The full size mould is then drawn out from this base line and divided up by the lines A, B, C, D and E, into either 1/16" or 1/8" according to size and intricacy of the shape, these lines are then struck round from the centre line radially to the face of the cutter.

At "X" the lines A1, B1, C1, D1, and E1 are carried across as shown, also at "W" the moulds produced exactly as at "Z" and divided up the same, the lines 1, 2, 3, 4 and 5 which are from the points where lines A, B, C, etc., intersect the edge of the mould, are then drawn across to "X" thus E1 is cut by 1; D1 by 2, etc. The points of intersection are joined as shown thus giving the correct projected form of the cutter. This takes up considerable time to do for each shape of cutters required, and can be very much reduced by using the moulder's rule on page 28 which is a graph on which the form can be plotted and automatically gives the necessary allowance on the depth of form.

When the mould is to be a standard, a template should be made to the projected form to which the cutters can be shaped when the job repeats. This will ensure uniformity on all future runs.

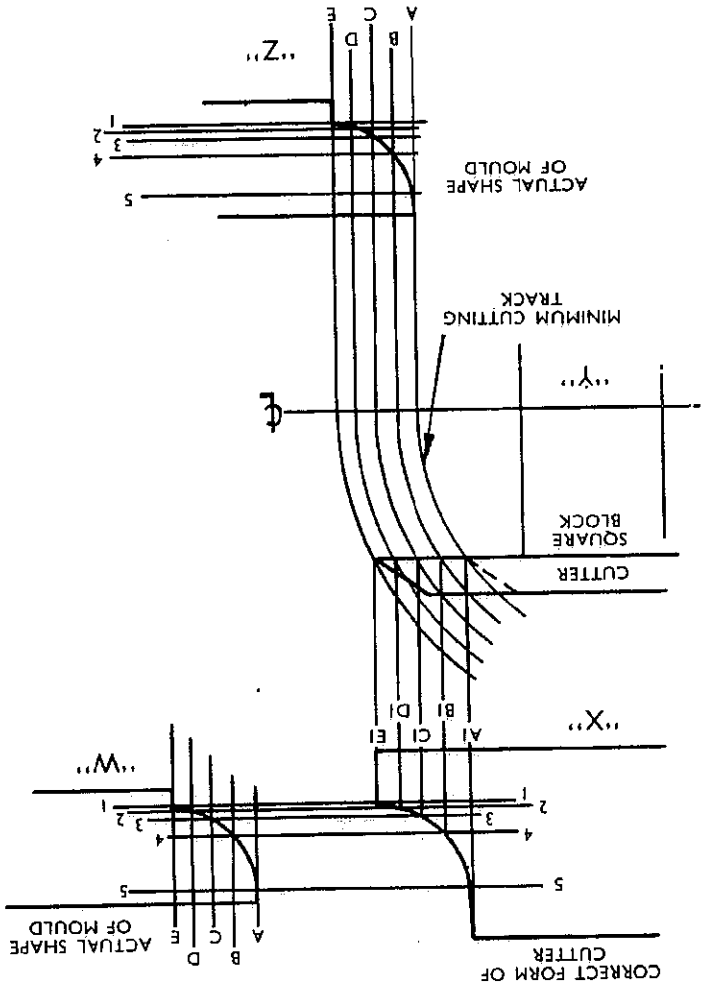

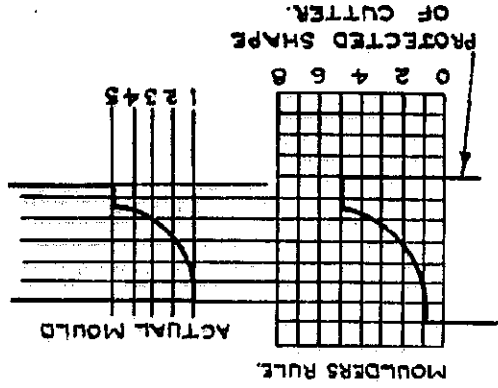

MOULDERS RULE FOR $3\frac{1}{2}$ " SQUARE BLOCKS
 $5\frac{1}{2}$ " dia. minimum cutting circle
 $7\frac{1}{2}$ " dia. maximum "

A permanent moulder's rule can be made by the customer in sheet brass or aluminium and will then be handy for use in the workshop.

To plot the form of a cutter by use of the moulder's rule it is necessary to draw the full size shape of the mould on tracing paper and rule $\frac{1}{8}$ " squares as diagrams. This is then placed alongside the moulder's rule and projected across, this will give a series of dots which must then be joined up to give the form of the cutter. The cutter blank chosen should be wide enough to give at least $\frac{1}{8}$ " overlap beyond the edge of the mould. The depth of the form cutter for the same mould varies slightly when used on a $3\frac{1}{2}$ " or 4" square cutterblock due to the different cutting diameters. Moulder's rules are required for each size of square block. The cutters are not interchangeable from one size of cutter block to another if a really accurate mould is required.

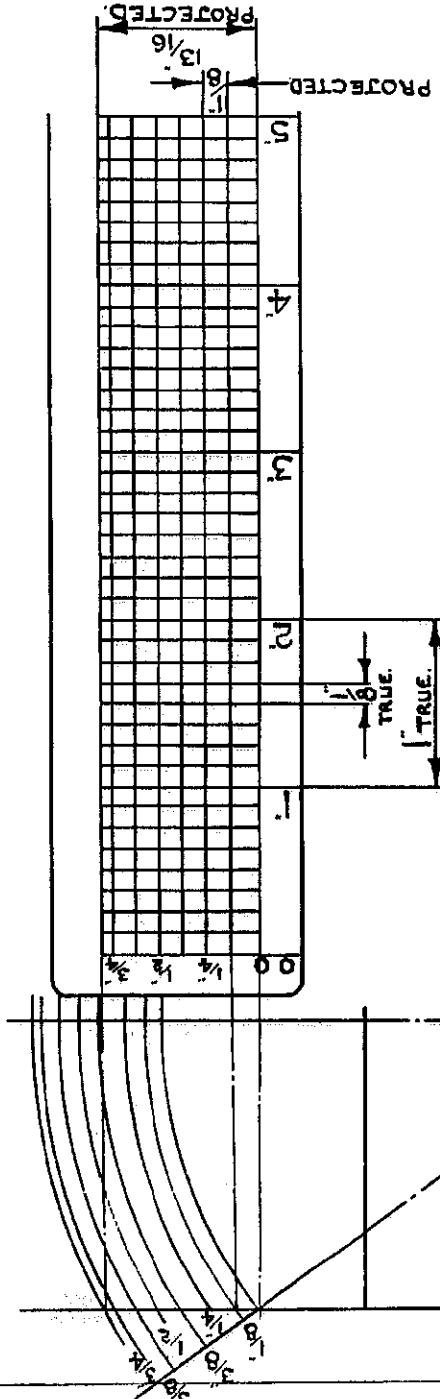

TYPICAL CUTTER LAYOUTS

In all cases where possible when using square blocks it is advisable to break up the cut over two or more pairs of cutters, this has many advantages as is shown in the following examples. Fig. 1. Simple rebate, by using two pairs of cutters there is very little grinding to be done, only side relief on the cutters B to give a good clean cut and prevent burning, cutters are mounted as shown in Fig. 5. This also spreads cut over the four sides of the block and gives a smoother action.

Fig. 2. Sash mould, this is best worked with three pairs of cutters, this enables correct side relief to be obtained on all cuts, it allows the same cutters to be used with varying widths of mould because they can easily be adjusted sideways.

Figs. 3. and 4. Hand Rail mould, this is broken up into three separate operations. At Fig. 3 the top is worked first so that timber runs on flat face, this cut is done by only one pair of cutters. At Fig. 4 the sides are worked in two operations, one pair of cutters doing all the side work.

By breaking the moulds up as illustrated, it is possible to use the same cutters for many moulds thus reducing the total quantity of cutters required, it makes grinding of side relief a simple operation and enables exact shape to be obtained by adjusting pairs of cutters across each other. It is essential to have each pair of cutters balanced for smooth running of the cutterblock.

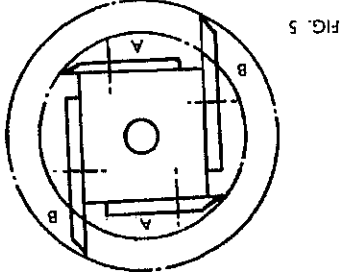
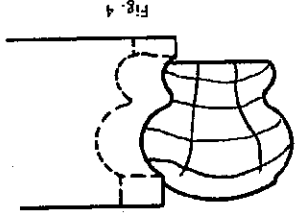
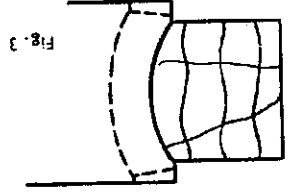
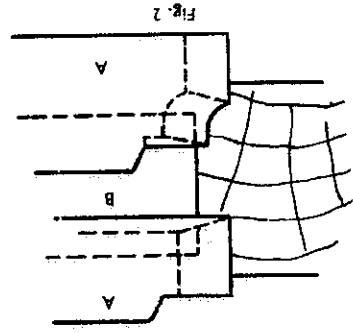
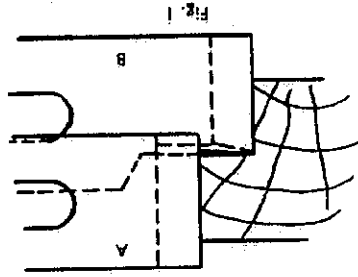

CUTTER GRINDING

Cutters should be ground carefully avoiding any overheating as this will crack or soften cutters so that they will not stand up to the work.

A solution of soluble oil and water should be handy and the cutters should be held in this occasionally to cool them. This solution will also prevent rusting. Cutters should never be allowed to become discoloured during grinding, as this indicates overheating.

The correct cutter angle of 35° for most cutters should be maintained, this is to give the correct strength to the cutting edge. When hollow grinding is carried out, the angle of the cutting edge should be kept as near 35° as possible, see Figs. 1 and 2.

Hollow grinding is recommended wherever possible, as a perfect cutting edge is more easily obtained by stoning. When stoning a flat ground cutter a good edge is more difficult to obtain due to the tendency to rock the stone and leave a convex face.

Good open grain wheels should be used and not allowed to become glazed, as this will cause excessive heat.

About 12" diameter for new wheels gives the best radius for the hollow grind and the economic life. 8" wheels used down to 6" leave the grind too hollow

Tungsten carbide tipped cutters should be bought to the shape required and only need re-grinding. In this case cutters should be relieved at 35° on steel and the tips finished with a diamond impregnated wheel at 45° as shown, using only very light cuts to prevent cracking. The diamond wheel should not be allowed to touch the steel backing as this clogs the wheel and causes excessive heat. Where available a copious flow of coolant should be used. They may be honed with a Diamond hand lap, as the cutter becomes dull, until a re-grind is necessary. A thin oil lubricant should be used on the hand lap.

All cutter blanks sent out by us are ground only and it used as chipper or rebate cutters require honing with a 142 Carborundum slip stone to produce a razor sharp edge before commencing to cut. This will ensure a good finish on the wood and an easy feed. Dull cutters give a poor, rough and plucked out finish, and make it difficult to feed the job past the cutters. Honing should be done by a reciprocating or rotary motion on the cutter, using a little paraffin to give "bite" to the stone. The honing stone is a much finer grit than the grinding wheel and leaves a sharp keen edge. A number of honing stones of different shapes, e.g. round sticks or square sticks will be found helpful in honing shaped cutters.

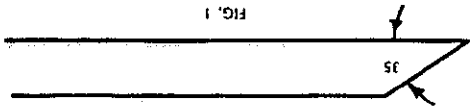

FIG. 1

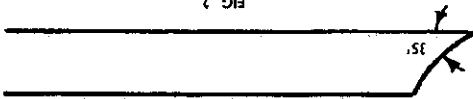

FIG. 2

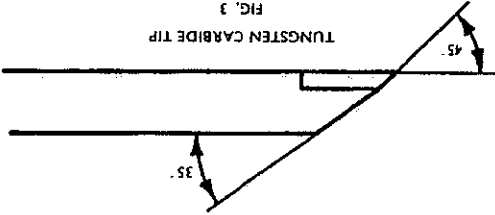

FIG. 3

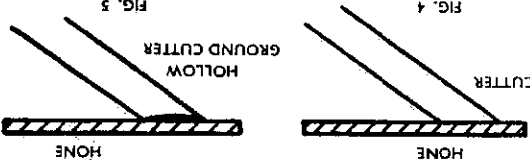

FIG. 4

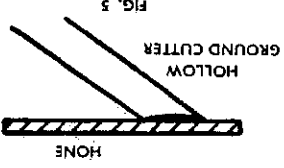

FIG. 5

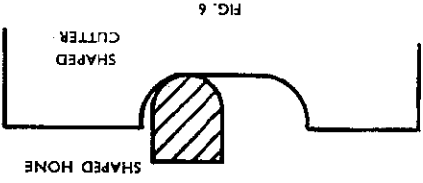
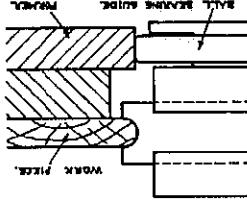
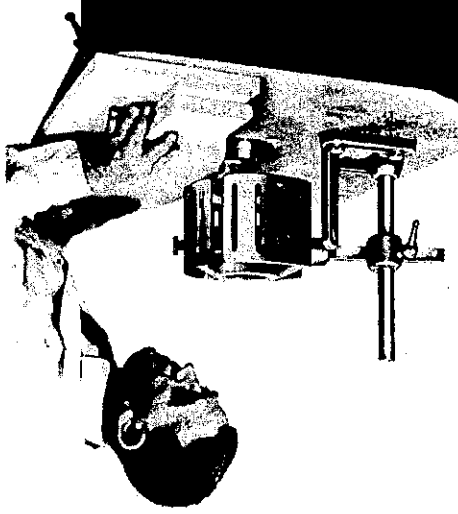
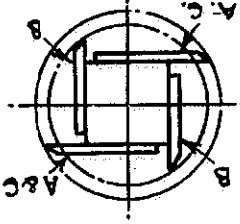
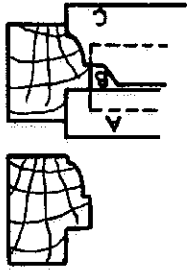
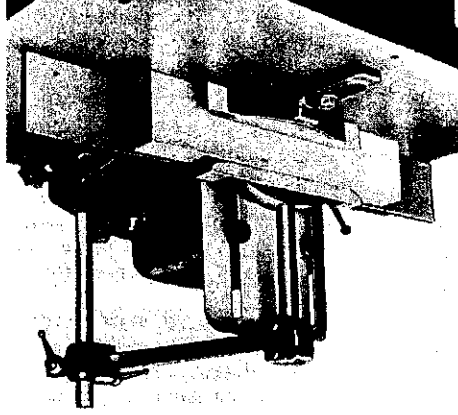

FIG. 6



TYPICAL SET UPS



FRAMING ON SQUARE BLOCK

Equipment required: - 1 1/4" loose screwed spindle, square block, three pairs of cutters, straight fences and spring pressures. The cutters will have to be shaped to suit the moulded portion, allowing for angle by using the moulder's rule. Each pair of cutters must be balanced to prevent vibration, then accurately set up on the square block using our setting and balancing stand F. D. T. if available, so that all are cutting. The cutterblock is then mounted on the spindle, fences set correctly in line, top and side spring pressure set to hold work firmly to the fences. Also universal adjustable guard over the top. Spindle speed 4,500 r. p. m.

Note: Cutters are always used in pairs to maintain balance.

SHAPED PANELS ON SLOTTED COLLARS

Equipment required: - 1 1/4" loose screwed spindle, one pair slotted collars with safety pins ball bearing, bottom, one pair shallow nosing cutters and a universal adjustable guard. The cutters are set up in the collars keeping minimum track in line with ball bearing guide on bottom collar, collars are mounted on a 1 1/2" diameter loose top piece, the brush handle is held by spikes to master former which is below the work. The universal guard is set to cover cutters and top piece. The former is passed across guide. The cutters are completely shielded from operator's hands by the work. Spindle speed 7,200 r. p. m.

CIRCULAR CUTTERBLOCK WORK

Equipment required: - 1 1/4" loose top piece and universal adjustable guard, 3" deep circular cutterblock, ring fence and set so that cuttertrack is in line with ring fence as shown in sketch. Guard is then set to cover up block and top piece leaving only sufficient room for work to pass underneath. Work to be mounted on shaped fixture which is held up to ring fence. Contact must always be at the same point on ring fence to ensure even depth of cut. This must be done due to the shape of the ring. The circular block gives a good smooth cut and finish to work.

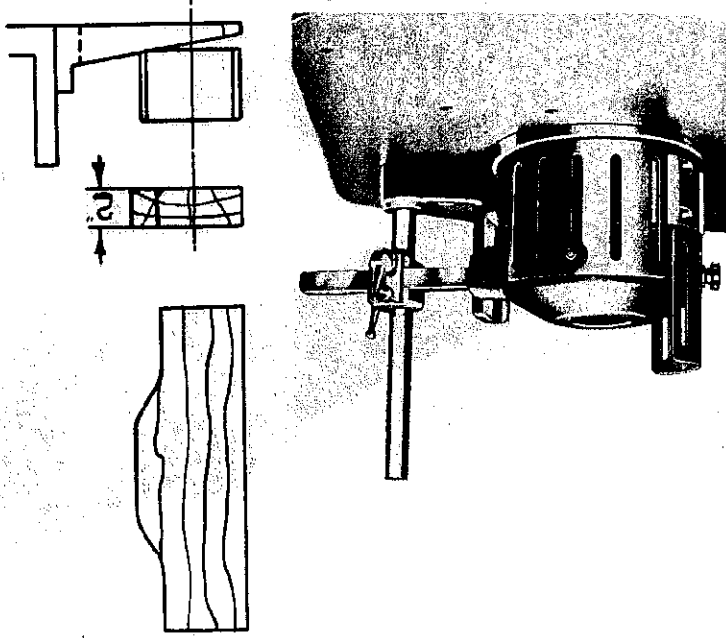

GENERAL HINTS

Use sharp cutters, reasonably balanced. Make good robust jigs and see the parts are located securely on the jig. Wadkin are always pleased to make recommendations and send a sketch of the contruction of a jig. NEVER run the cutter equipment at higher then the recommended speed. Always use the guards provided to ensure maximum protection. Make sure the cutters are tight on the block before starting up. Use the spanners provided and do not fit a piece of piping to get greater leverage. This will strain the nuts and bolts and ultimately make them unsafe. NEVER pack cutters with sandpaper. This is most dangerous as the grit collapses when the cutter is working and the cutter works loose. For packing use one thickness only of thin brown paper. Keep nuts and bolts clean and use oil on the threads.

... blow away harmful dust, chips and dirt with a Wadkin Electric Blower

No motor can run at its maximum efficiency with its ventilating duct or control gear covered with dust and dirt. Sooner or later the resultant overheating will cause serious trouble. Similarly, accumulations of chips and dust, in the mechanical parts of the machine can interfere with its efficiency. A few minutes a week for blowing down all Woodworking Machinery will be amply repaid in better and easier running, in increased life, and freedom from breakdown. Blowers can be supplied for single phase A.C. or Direct Current for any voltage up to 250. Please state voltage when ordering.

